



HIGH PERFORMANCE LIQUID CHROMATOGRAPHY(HPLC)

PRESENTED

BY

Dr Mandava Kiranmai



High Performance Liquid Chromatography

HPLC is characterized by the use of **high pressure** to push a *mobile phase* solution through a **column** of *stationary phase* allowing separation of complex mixtures with **high resolution**.

HPLC

Photo: Didier Leguay 2002



GC



COMPARISION OF HPLC & GC

<u>CRITERIA</u>	<u>GC</u>	<u>HPLC</u>
PRINCIPLE OF SEPERATION	<ol style="list-style-type: none">1) <i>Adsorption</i>2) <i>Partition</i>	<ol style="list-style-type: none">1) <i>Adsorption</i>2) <i>Ion exchange</i>3) <i>Partition</i>4) <i>Ion pair</i>5) <i>Size exclusion</i>6) <i>Affinity</i>

CRITERIA

GC

HPLC

TYPES OF CHROMATOGRAPHY

Scale of operation

- 1. *Analytical GC*
- 2. *Preparative GC*

Type of adsorbent

- 1. *GSC*
- 2. *GLC*

Scale of operation

- 1. *Analytical HPLC*
- 2. *Preparative HPLC*

Modes of chromatography

- 1. *Normal phase*
- 2. *Reverse phase*

Elution technique

- 1. *Isocratic elution*
- 2. *Gradient elution*

CRITERIA

GC

HPLC

INSTRUMENTATION

1. *Mobile phase*
Carrier Gas
e.g., Hydrogen,
Helium,
Nitrogen, CO₂
2. *Columns*
 - a. *Packed columns*
 - b. *Capillary columns*

1. *Mobile phase*
Liquid
2. *Columns*
 - a. *Analytical*
 - b. *preparative*

CRITERIA

GC

HPLC

INSTRUMENTATION

1. Pumps

- a. High pressure gas reservoirs*

1. Pumps

- a. Constant displacement or Syringe pumps*
- b. Reciprocating pumps*
- c. Constant pressure or pneumatic pumps*

CRITERIA

GC

HPLC

INSTRUMENTATION

1. Detectors

*1. Flame ionization
(FID)*

*2. Thermal
conductivity
(TCD)*

*3. Electron capture
(ECD)*

*4. Flame photometric
(FPD)*

*5. Photo-ionization
(PID)*

1. Detectors

*1. The refractive index
detector*

2. The UV detectors

*3. The fluorescence
detector*

3. Amperometric



HPLC

**OPERATION
&
INSTRUMENTATION**

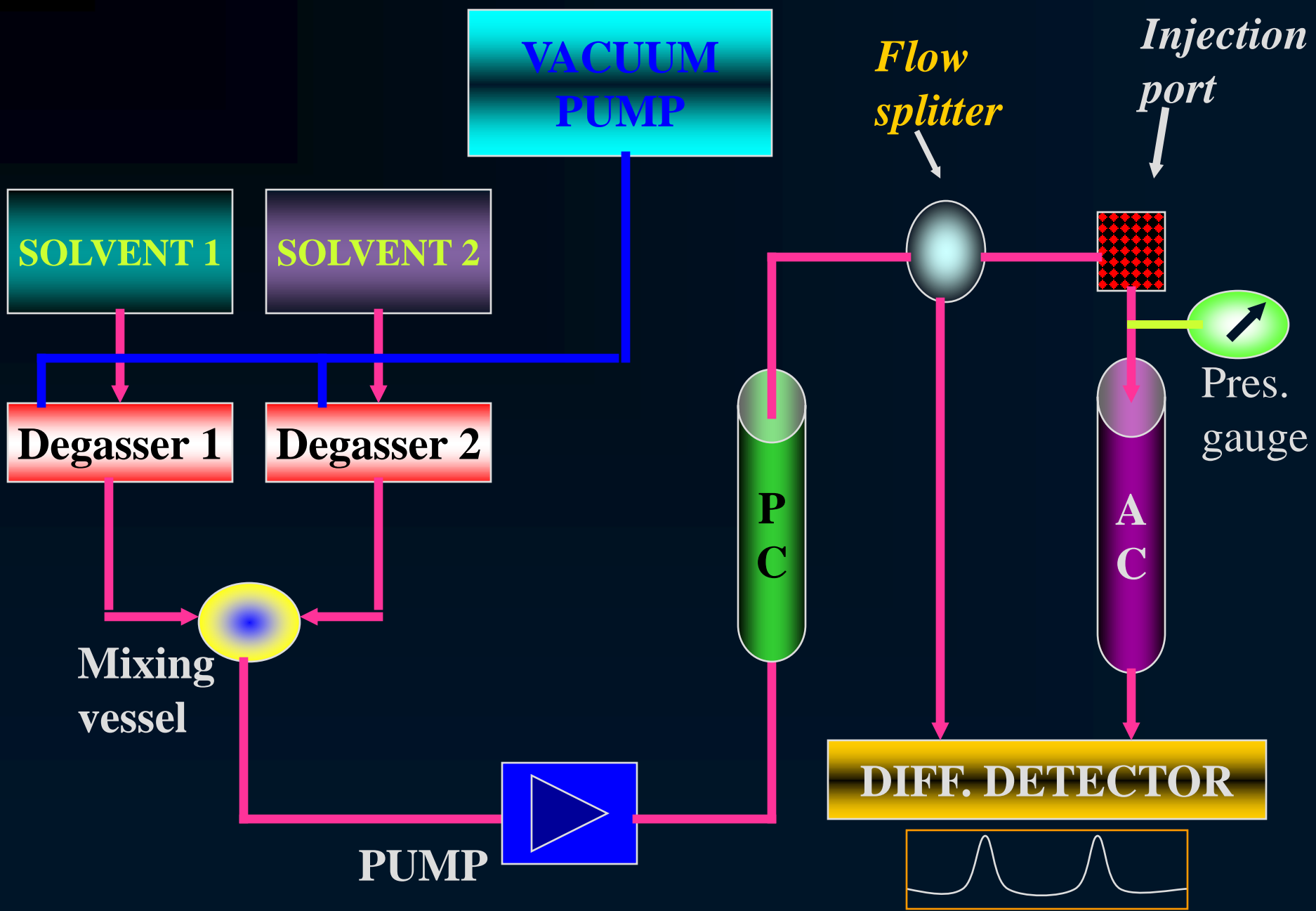

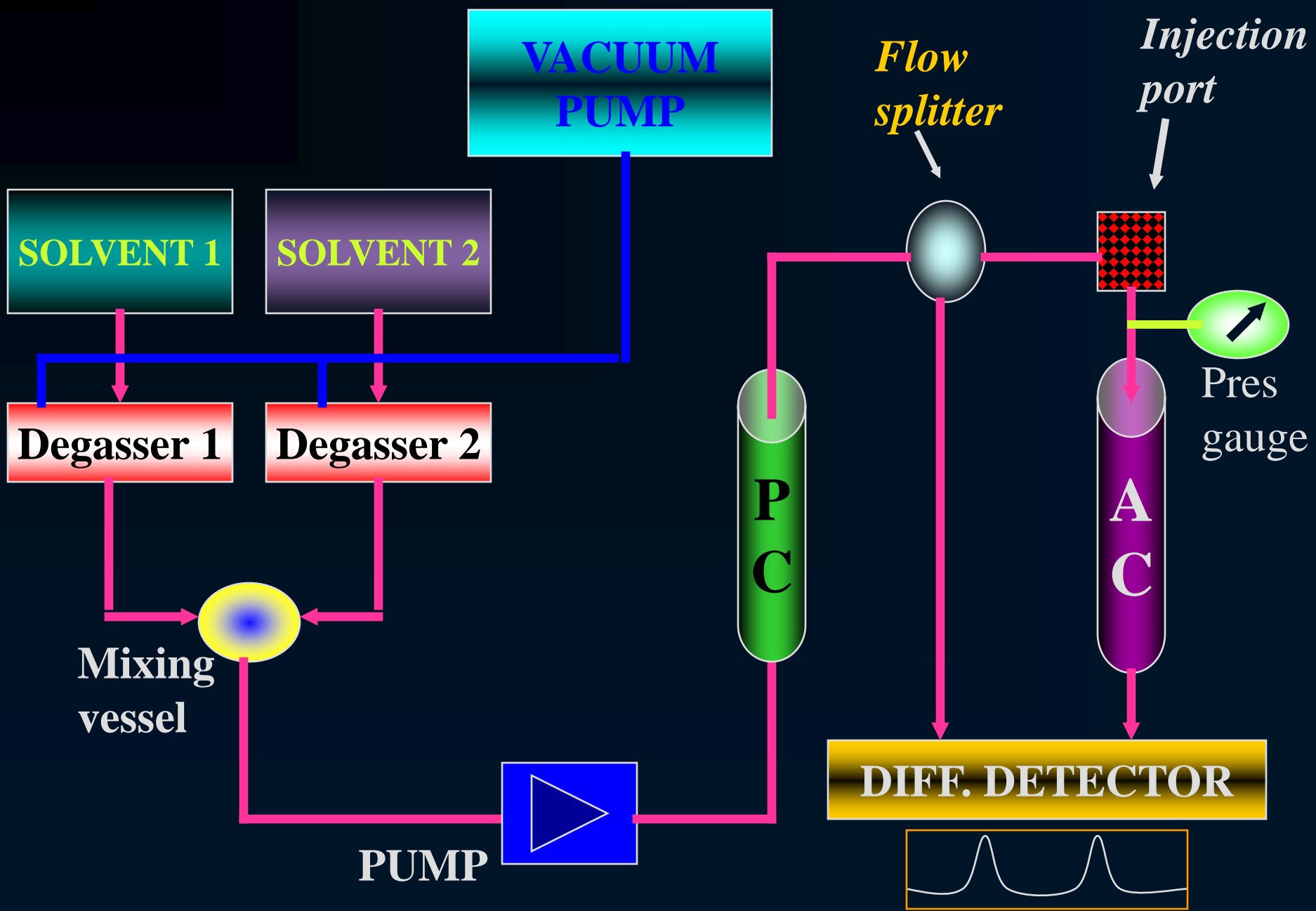

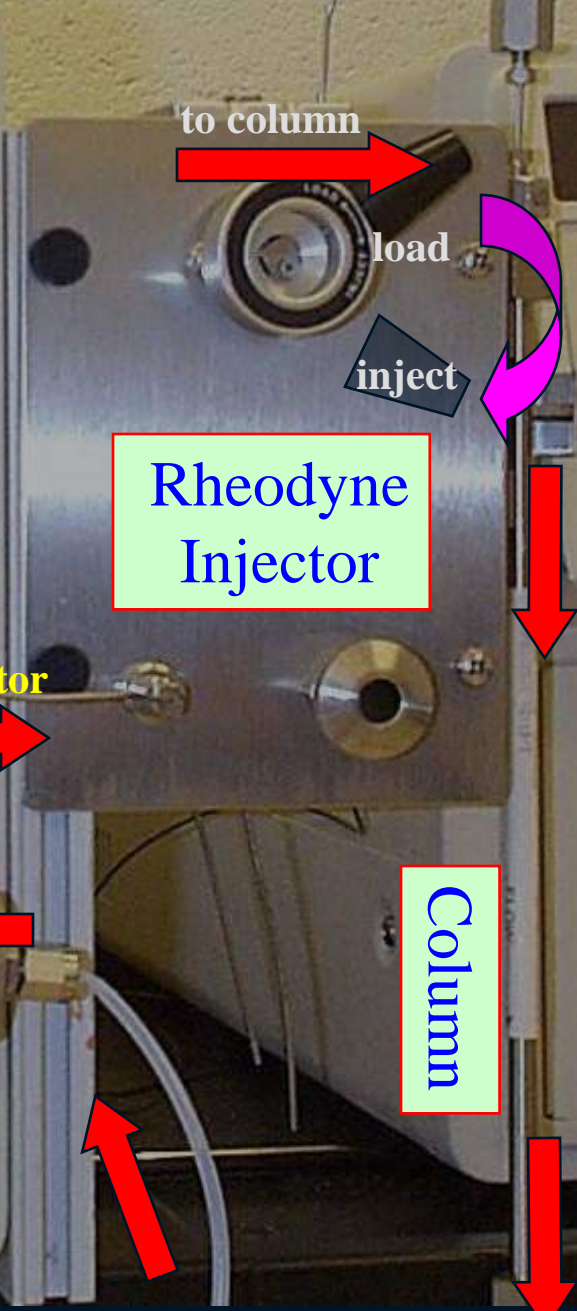
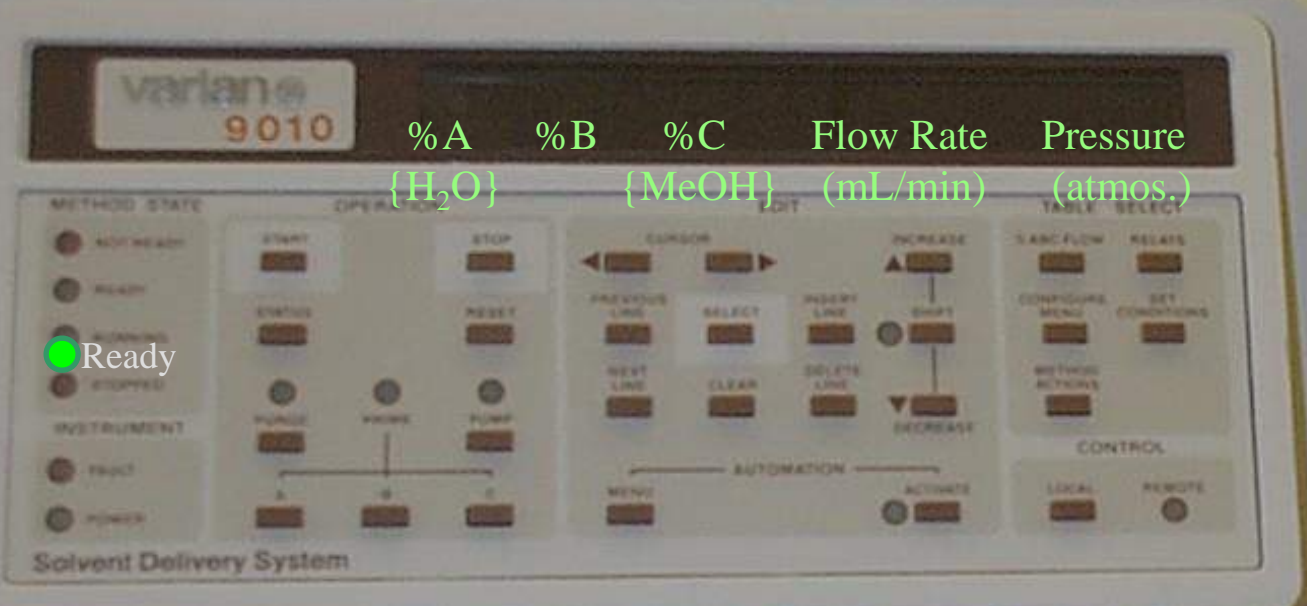

Solvent Delivery System

Rheodyne Injector

Column

Ternary Pump

through pulse dampener

through pump

from solvent reservoir

to detector

A

B

C

through pulse dampener

to injector

to column

load

inject

HPLC System

HPLC Solvent
Reservoirs

Solvent
Delivery System

Variable
UV/Vis Detector

Polychrom
(Diode Array) Detector

Computer
Workstation

Rheodyne
Injector

HPLC
Column

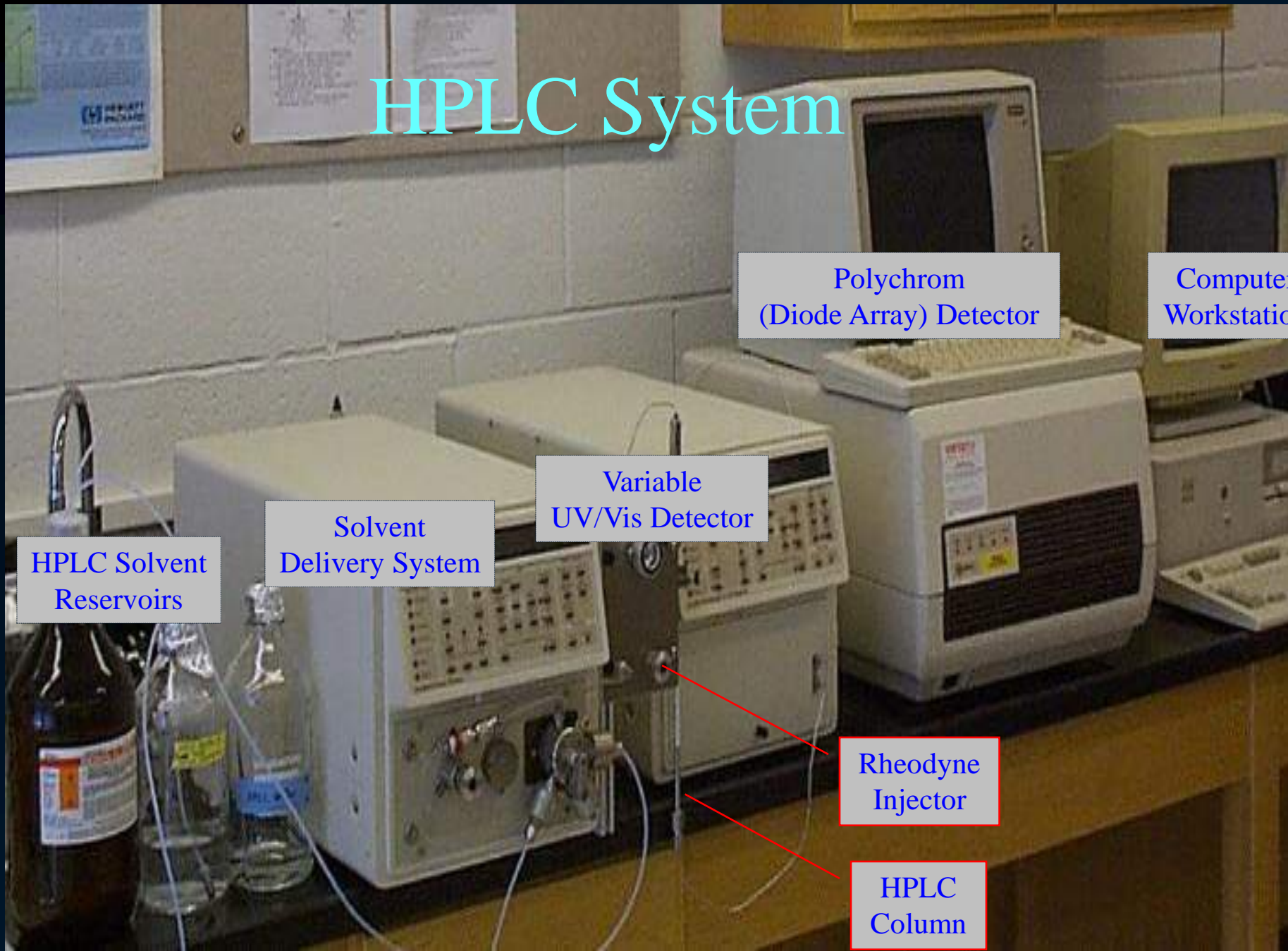

HPLC - INSTRUMENTATION

- ▼ *Solvent reservoir system*
- ▼ *Pumps*
- ▼ *Sample injection system*
- ▼ *Columns*
- ▼ *Detector*
- ▼ *Recorder and integrators*

SOLVENT RESERVOIR SYSTEMS

- ✚ These are the glass bottles used to store the mobile phase.*
- ✚ The mobile phase is pumped under pressure from one or several reservoirs and flows through the column at a constant rate.*
- ✚ Desirable feature in the solvent delivery system is the capability for generating a solvent gradient.*
- ✚ Degasser is needed to remove dissolved air by subjecting the mobile phase under vacuum, distillation, sparging, heating or by ultrasonic stirring.*

PUMPS

IDEAL CHARACTERISTICS

- Non corrosive & compatible with solvent.
- Provide high pressure to push mobile phase.
- Provide constant flow rate to mobile phase.
- Easy to change from one mobile phase to another.
- Should have reproducible flow rate and independent of column back pressure.
- Should not leak.
- High pressure generated by pump should not lead to an explosion.

TYPES OF PUMPS

- 1. RECIPROCATING PUMP**
- 2. DISPLACEMENT PUMP / SYRINGE PUMP**
- 3. PNEUMATIC PUMP**

RECIPROCATING PUMP

WORKING

- ✚ *Contains reciprocating piston that moves back and forth in hydraulic chamber.*
- ✚ *By the movement of piston solvent flow into the column under high pressure.*
- ✚ *When the piston moves backward inlet valve open while exit valve closes. This results in mobile phase being drawn into the main chamber.*
- ✚ *When the piston moves to the front the inlet valve closes & the exit valve opens.*

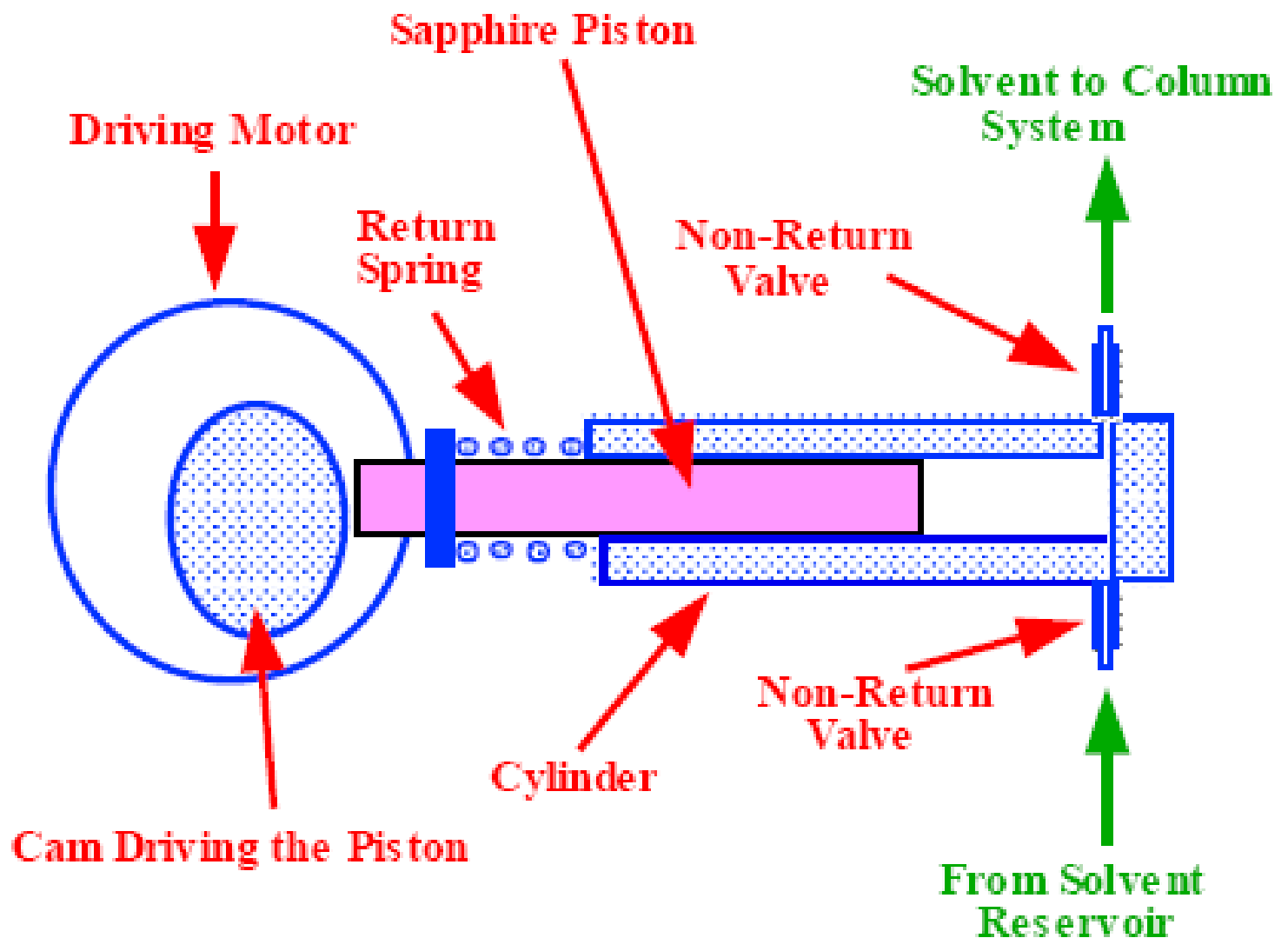

Figure 7. A Single Piston Reciprocating Pump

RECIPROCATING PUMP

ADVANTAGES :

- Generates high output pressure (upto 10,000 poise).
- Ready adaptability to gradient elusion.
- Provide constant flow rate.
- Pressure generated is so high that any back pressure can be easily overcome.

RECIPROCATING PUMP

DISADVANTAGES :

- ▣ Pulsed flow which must be damped as they produce a base line noise on the chromatogram.

DISPLACEMENT PUMP

WORKING :

- ✚ Works on the principle of positive solvent pressure.*
- ✚ Consists of screw or plunger which revolves continuously driven by motor.*
- ✚ Rotatory motion provides continuous movement of the mobile phase which is propelled by the revolving screw at greater speed & pushes solvent through small needle like outlet.*
- ✚ Consists of a large syringe like chamber of capacity 250-500 ml.*

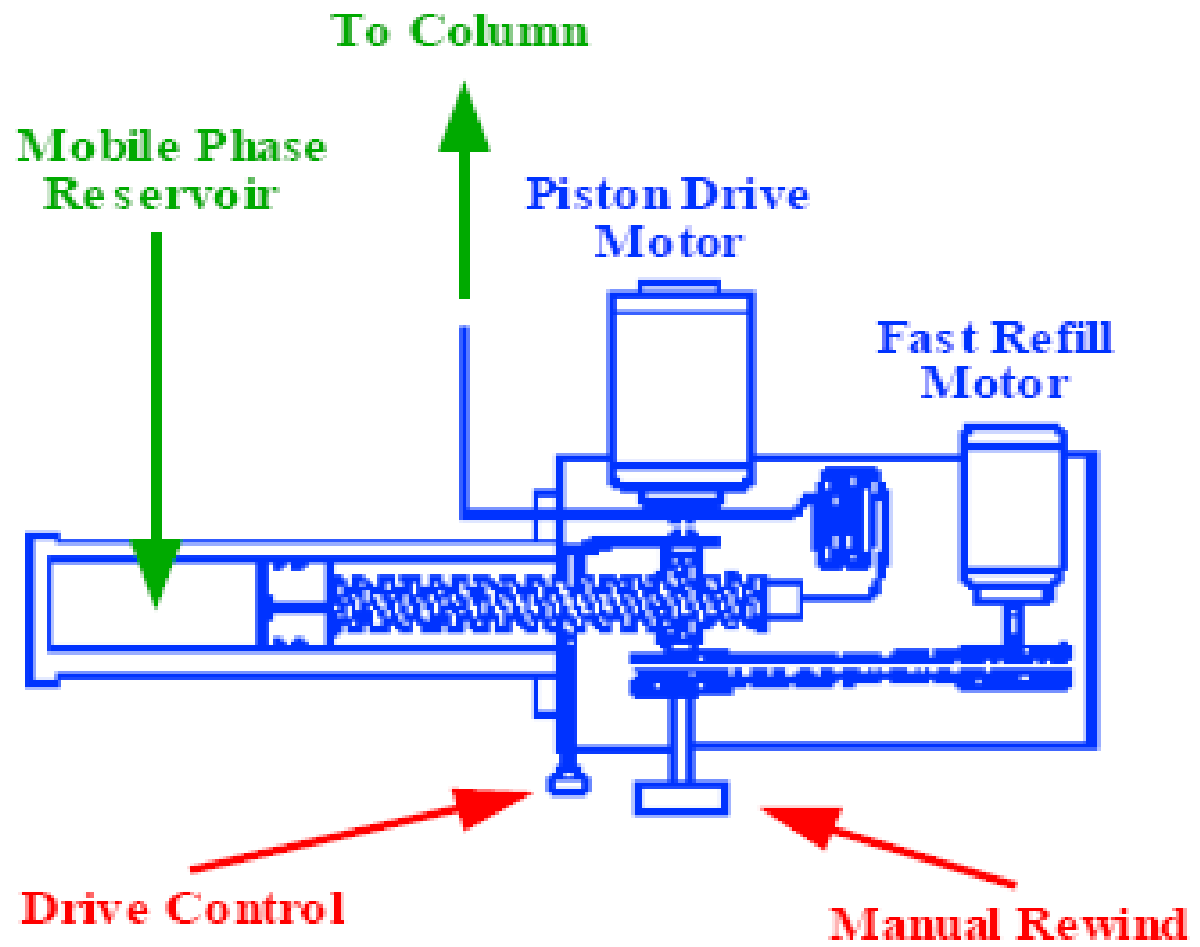

Courtesy of the Perkin Elmer Corporation

Figure 6. The Syringe Pump (Displacement pump)

DISPLACEMENT PUMP

ADVANTAGES :

- ▣ Flow is pulse free.
- ▣ Provide high pressure upto 200-475 atm.
- ▣ Independent of column back pressure & viscosity of the solvent.
- ▣ Simple operation.

DISPLACEMENT PUMP

DISADVANTAGES :

- ▣ Limited solvent capacity.
- ▣ Gradient elution is not easy.

PNEUMATIC PUMP

WORKING :

- Pressure from a gas cylinder delivered through a large piston drives to the mobile phase.
- Pressure on the solvent is proportional to the ratio of piston usually 50:1.
- The driving air is applied, piston moves, inlet closes & outlet open pushing mobile phase to the column.
- A lower pressure gas source of 1-10 atm can be used to generate high liquid pressure.(1-400 atm)
- About 70 ml of the mobile phase is pumped from every stroke.

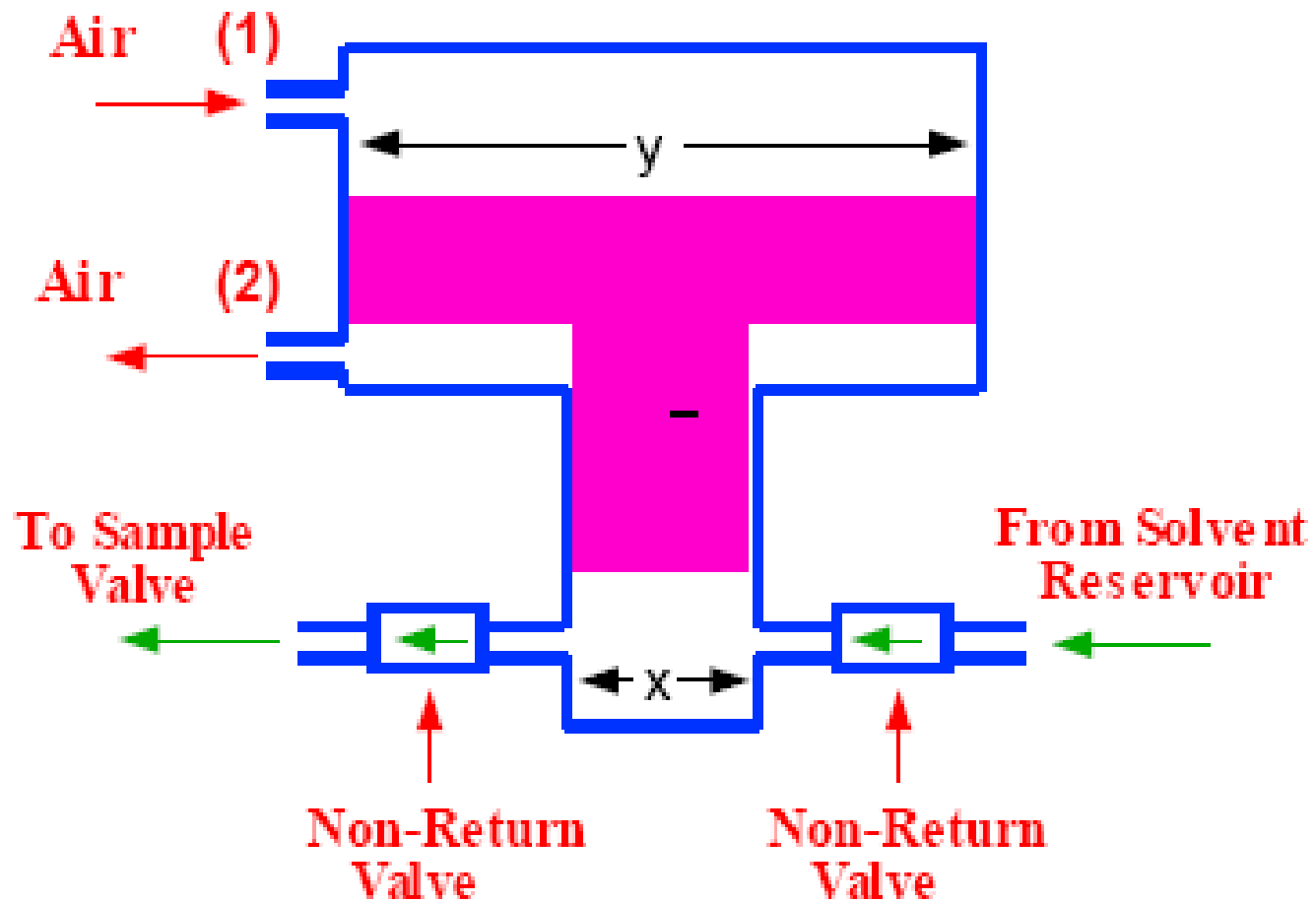

Figure 4. A Diagram of the Pneumatic Pump

PNEUMATIC PUMP

ADVANTAGES :

- ✚ Flow is pulse free.
- ✚ Provide high pressure upto 400 atm.

PNEUMATIC PUMP

DISADVANTAGES :

- ▣ Limited volume capacity (70 ml).
- ▣ Pressure output & flow rate depends on the viscosity & column back pressure.
- ▣ Gradient elution is not possible.

SAMPLE INJECTION SYSTEM

1. Septum injectors.
2. Stop flow septumless injection.
3. Rheodyne injector / loop valve type.



Septum injection port

Syringe is used to inject the sample through an self sealing inert septum directly into the mobile phase.

Draw back – Leaching effect of the mobile phase with the septum resulting in the formation of ghost peaks.



Stop flow septumless injection

Flow of mobile phase through the column is stopped for a while. Syringe is used to inject the sample.

Draw back –Formation of ghost peaks.



Rheodyne injector/loop valve type

ADVANTAGES :

- Sophisticated modern method with good precision.
- Sample is introduced in the column without causing interruption to mobile phase flow.
- Volume of sample ranges between $2\mu\text{l}$ to over $100\mu\text{l}$.



Rheodyne injector/loop valve type

OPERATION OF SAMPLE LOOP:

1. Sampling mode.
2. Injection mode.

Sample is loaded at atmospheric pressure into an external loop in the micro volume sampling valve & subsequently injected into the mobile phase by suitable rotation of the valve.

COLUMNS

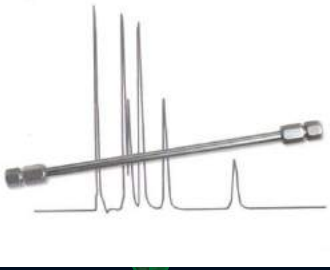

- *Made up of stainless steel or heavy glass to withstand the pressure.*
- *The columns are usually long (10-30 cm) narrow tubes. Contains stationery phase at particle diameters of 25 μm or less.*
- *The interior of column should be smooth & uniform.*
- *Column end fitting are designed to have a zero void volume.*

CLASSIFICATION OF COLUMNS

COLUMN

**MAIN
COLUMN**

**GUARD
COLUMN**

STANDARD COLUMN

MICROPREPARATIVE

NARROW BORE COLUMN

MACROPREPARATIVE

SHORT FAST COLUMN

PREPARATIVE COLUMN



Analysis

Preparation



Analytical columns

STANDARD COLUMN

-  Internal diameter 4-5 mm & length 10-30cm.
-  Particle size of stationary phase is 3-5 μm in diameter.
-  Used for the estimation of drugs, metabolites, pharmaceutical preparations & body fluids like plasma.



Analytical columns

- **NARROW BORE COLUMN**
 - Internal diameter 2- 4 mm.
 - Require high pressure to propel mobile phase.
 - Used for the high resolution analytical work of compounds with very high Retention Time.



Analytical columns

● SHORT FAST COLUMN

- Length of column is 3-6 cm.
- Used for the substances which have good affinity towards the stationary phase.
- Analysis time is also less (1- 4 min for gradient elution & 15-20 min for isocratic elution)



Preparative columns

Used for analytical separation i.e., to isolate or purify sample in the range of 10-100 mg from complex mixture.

- Length 25-100 cm
- internal diameter 6 mm or above



Preparative columns

● MICROPREPARATIVE COLUMN

- Modified version of analytical column.
- Used for purifying sample less than 100 mg.

● PREPARATIVE COLUMN





- Inner diameter 25 mm.
- Stationery phase diameter 15- 100 μm .

● MACROPREPARATIVE COLUMN

- Column length 20-30 cm.
- Inner diameter 60 mm.



GUARD COLUMNS

-  They are placed anterior to the separating column.
-  Serve as a protective factor that prolongs the life & usefulness of the column.
-  They are dependable column designed to filter or remove
 -  particles that clog the separation column.
 -  compounds & ions that could ultimately cause baseline drift, decrease resolution, decrease sensitivity & create false peaks.



CATEGORY OF DETECTOR USED IN HPLC

- ▣ bulk property detector
- ▣ Solute property detector
- ▣ Multi purpose detector
- ▣ Electrochemical detector

Types of Detectors

- Absorbance (UV with Filters, UV with Monochromators)
- IR Absorbance
- Fluorescence
- Refractive-Index
- Evaporative Light Scattering Detector (ELSD)
- Electrochemical
- Mass-Spectrometric
- Photo-Diode Array



Refractive index detectors

▣ Also known as RI-detectors and refract meter

▣ Principle:

The velocity of an electromagnetic wave will vary as it passes from one medium to another, the ratio of the speed in vacuum to that in a given medium is known as refractive index of the medium.



✓ RI measurement can be used to detect any compound and it is property of material, which transmit the light.

- ✓ When light passes from one to other medium reflection and refraction of the beam occur.
- ✓ At the interface between the two medium, the light splits in to a reflected part which does not enter the liquid, and a refracted part which carries on into the mobile phase, but with altered direction.



▼ The deflection is given by Snell's law of refraction

▼ $\sin \theta_i / \sin \theta_r = R.I$

▼ Change in leads to a change in angle of refraction, and this can be evaluated by a position sensitive detector to give a measure RI.

▼ Change in direction or intensity of refracted ray has been used in HPLC RI detectors.

DESIGN AND OPERATION OF RI DETECTOR

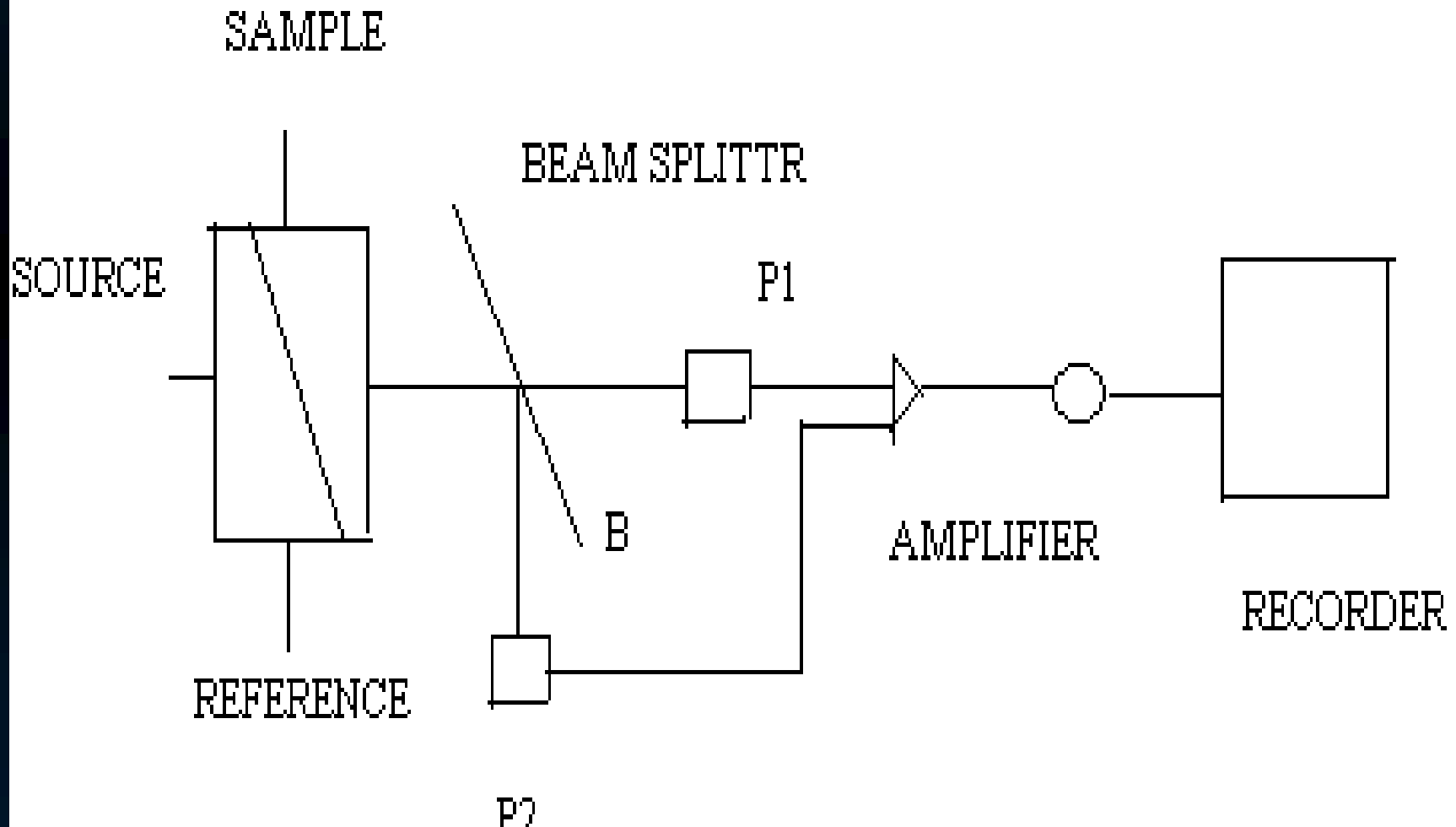



ELECTROCHEMICAL DETECTOR

✓ PRINCIPLE

- ✓ **The principle** of an amperometric detector is the oxidation or reduction of analyte in a flow through electrolysis cell with a constant applied electrical potential.



Very low detection limits can be achieved with amperometric detectors, particularly for compounds, which are oxidized or reduced at relatively low potentials.

Detector where only low percentage of the analyte is reacted are termed amperometric while those where almost all the analyte reacts are called coulometric detectors.

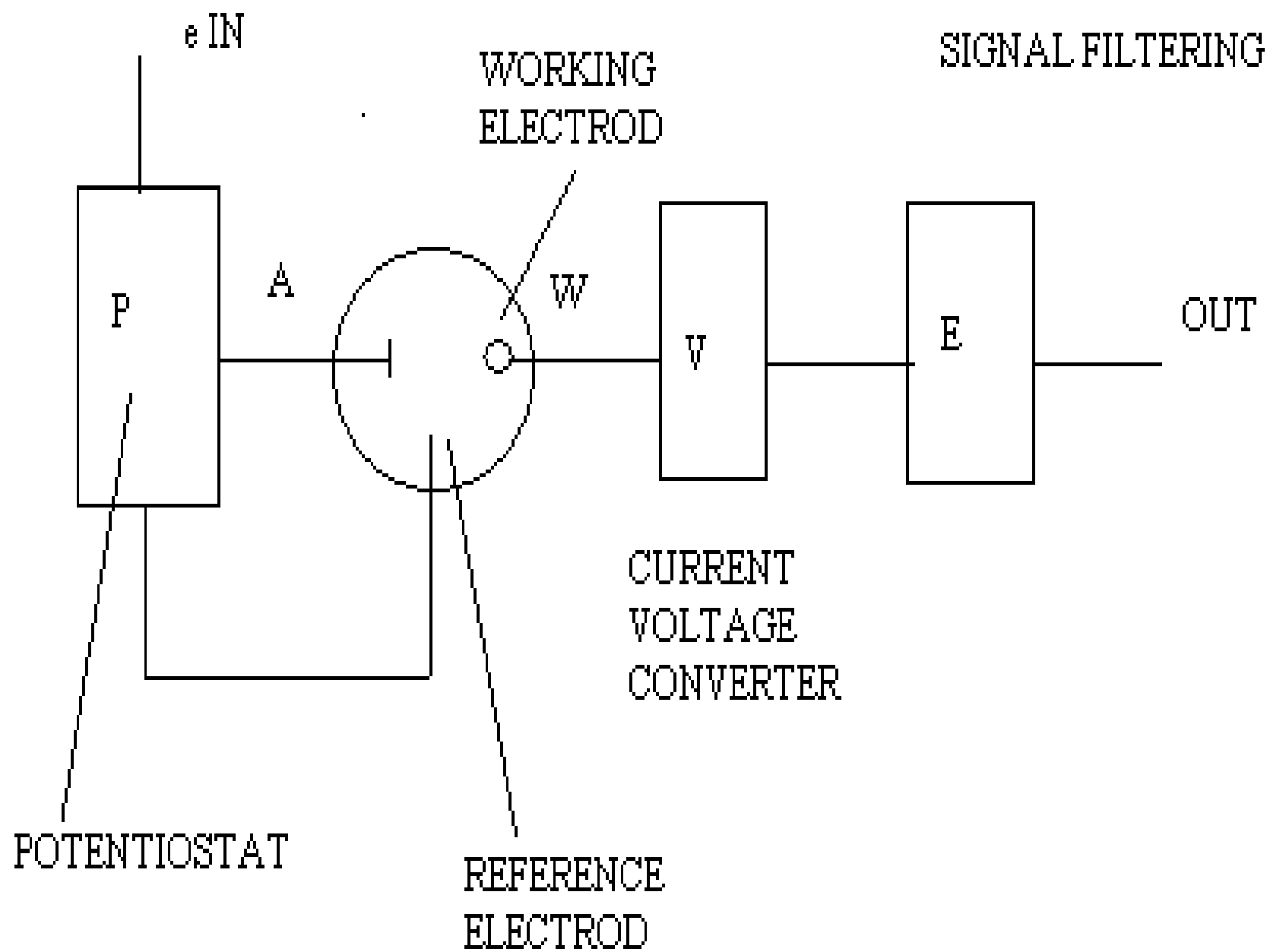



PHOTOMETRIC DETECTORS

▼ FLUORESCENCE DETECTORS

▼ UV DETECTOR



FLUORESCENCE DETECTORS

- ✓ When light is absorbed by a molecule and an electron is promoted to a higher energy state there are a number of pathways by which this energy can be dissipated, allowing a return to the ground state.
- ✓ Most commonly energy is lost by transfer to surrounding molecules and contributes only to an over all heating of the environment.

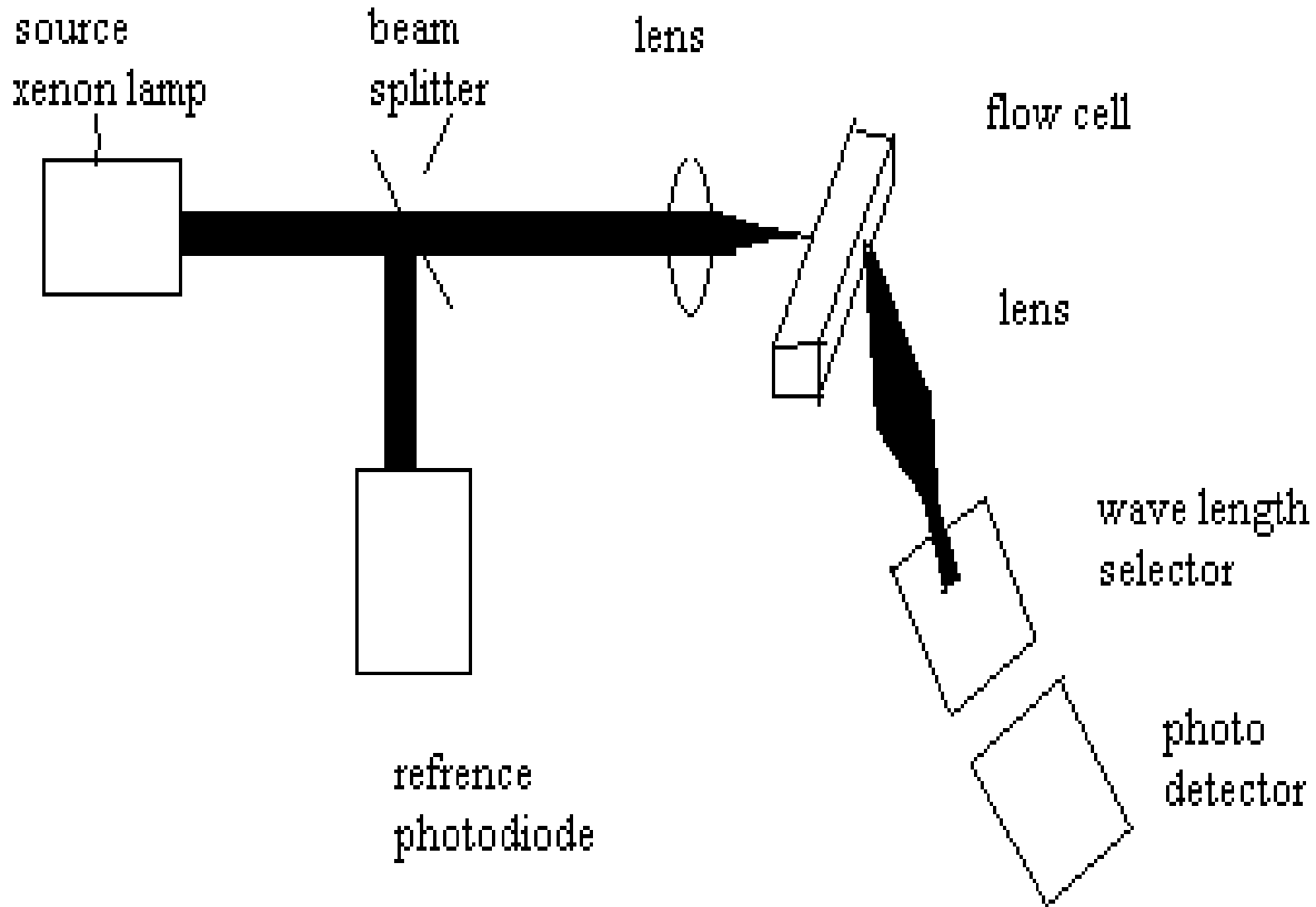



U.V detector

▼ Principle

- ▼ Many compounds absorb uv light.
- ▼ This is due to photon. When photon of light interacts with a molecule to promote an electron from a lower to a higher energy bound state. The property forms the basis of the detection system for HPLC



- ▼ UV absorbance detectors provide an output signal proportional to absorbance rather than transmitted light intensity.
- ▼ Which is useful since absorbance is directly proportional to the concentration of sample.

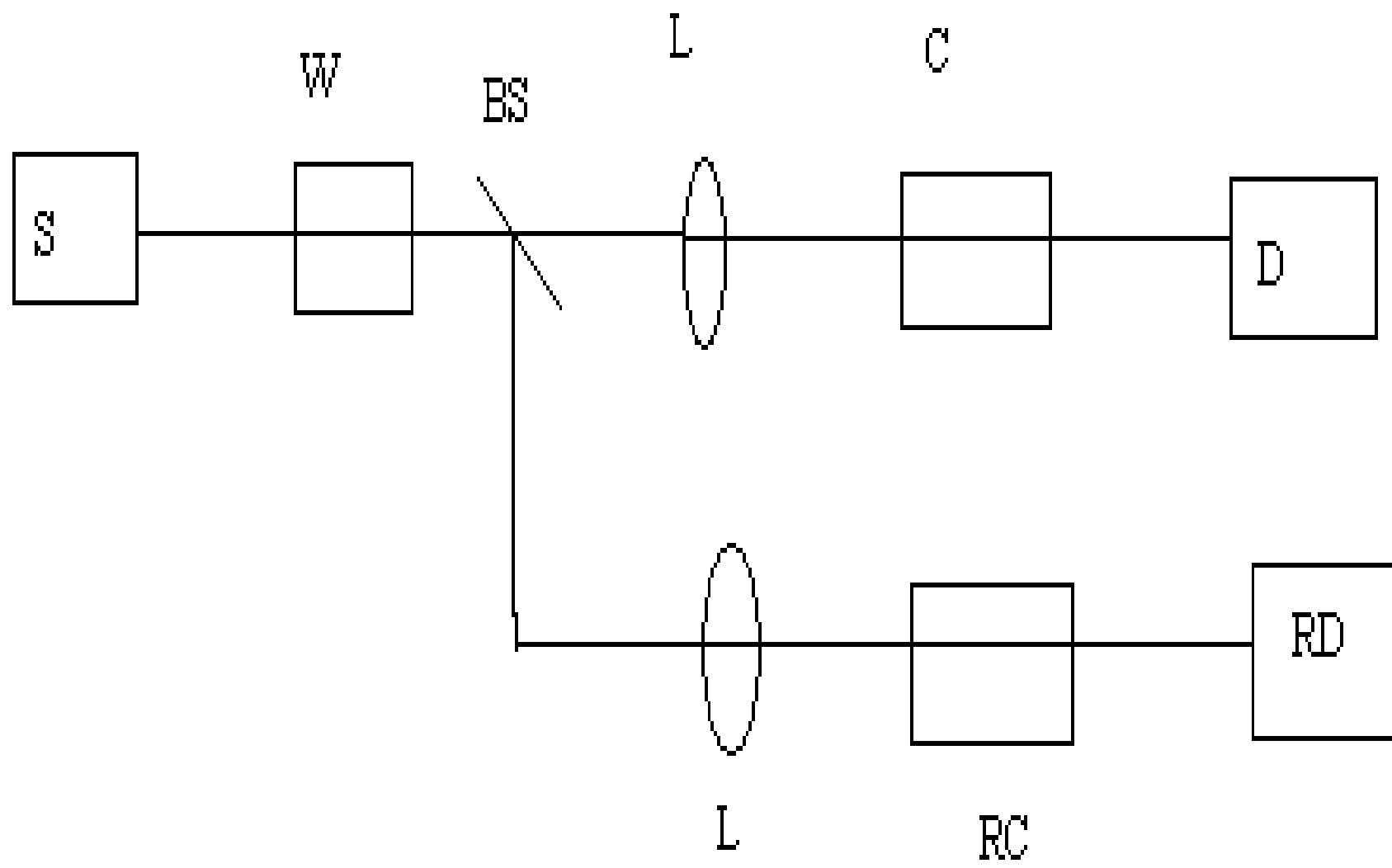



THREE MAIN TYPE:

✓ fixed wavelength

✓ Variable wavelength and

✓ Spectrophotometric detectors.

QUANTITATIVE

EVALUATION ON TLC

LAYER

✓ Determination by measurement of spot areas

- ✓ The spots are can be measured in several ways like
 - ✓ Comparison with suitable standard size
 - ✓ Evaluation with a planimeter,
 - ✓ Copying on to writing paper and weighing,
 - ✓ Copying photographically and weighing, or
 - ✓ Coping on to squared paper and counting the number of suare millimeters.



Quantitative determination of fluorescing spots direct evaluation

✓ Can be determined direct by following formula

✓ $F = s \times f$

✓ Where F = fluorescence value, read from detector

S = radiation density of a fluorescent spot, regarded as a light source

f = spot area

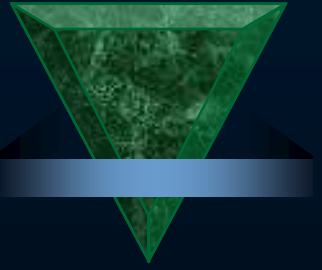

Photographic evaluation

✓ If a film is exposed to a fluorescing spot as light source so that the relation

$$Q = k \times \log I \dots\dots\dots(1)$$

Where,

Q = substance amount

I = emitted light intensity and

k = a property constant, the film
blackens

- 
- ✓ If the total extinction (D) of such aspot is measured with a densiometer,

$$D = \gamma \log I + B \quad \dots\dots\dots (2)$$

- ✓ At constant time of exposure,

$$B = \gamma (\log t - \log i)$$

t = time of exposure of the film

I = film “inertia”



✓ Combination (1) and (2) to give

$$D = K \times Q + B$$

Where , $K = \gamma/k$

✓ Total extinction measured by the densitometer amount of the substance applied.



Detection of the separated substances

- ✔ Detection is easy if the substances are colored
- ✔ For colorless substances reference chromatograms or reagent are use.
- ✔ Just like paper chromatograms, at least two start spots are applied.
- ✔ After development, one chromatogram is sprayed with a colored producing reagent, while the second chromatogram is covered and then marked at positions corresponding to those of the colored spots of the first.

- 
- ✔ Its required very homogeneous adsorbent layers so as to guarantee the most uniform possible solvent migration.
 - ✔ Examples: vitamin D₂, opium alkaloids.
 - ✔ Use of adsorbents containing fluorescent inorganic pigment is advisable, which absorbed in the UV region and appear as dark
 - ✔ The sensitivity of detection depends on the absorption maximum and the specific absorption of the chromatographed substances.



Advantages

- ✔ Separated materials can be detected without being chemically modified in any reaction.
- ✔ Fluorescent indicators are soluble in solvents of polarity appropriate for development and elution because they dissolve to some extent

Disadvantage

- ✔ Interfere in certain methods of determination

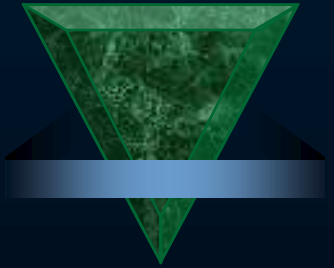

Non- destructive detection by spraying with water

- ✓ Lipophilic substances can be detected by this method
- ✓ Its depends on the wetting properties of adsorbent and substance.
- ✓ Example: steroids



Localization of separated spots with iodine vapor

- ✔ Substances which do not adsorbed in the UV can be detected by this method
- ✔ The iodine “coloration” due to solubility of iodine in the substance, adsorption or on formation of definite addition compounds.
- ✔ Excess iodine is removed with a current of air
- ✔ Example: caffeine, aminopyrine, phenacetin



Removal of spots from the plate and elution technique

- ✓ First to remove the adsorbent from a zone around the spots and then scrape off the spot itself on to a sheet of smooth cellophane.
- ✓ The spots can be scraped off with razor blade or spatula.
- ✓ Then extracted by shaking with the chosen solvent and the extract freed from adsorbent by



- ✓ Filter paper and the membrane filters could not be used for their poor resistance to organic solvents.
- ✓ Glass or porcelain filters are generally used.
- ✓ Methanol-insoluble membrane filters in the extraction of TLC spots are recently used.



References:-

- ✔ Stahl Eagon. Thin layer chromatography. 2nd ed, Springer-Verlag Berlin Heidelberg; New york: 1969.
- ✔ Munson james W. pharmaceutical analysis part-B. Mrcell Dekker Inc: 2001.
- ✔ Ashutoshkar. Pharmaceutical drug analysis.
- ✔ P.D. Shethi. HPLC-quantitative analysis of pharmaceutical formulations.
- ✔ P.D. Shethi. High performance liquid chromatography.

W
H
A
R
E

